

# ATPS22 Series

## Anti-Vandal Short-Body Sealed Pushbutton Switch



### Specifications

Function	SPST
Contact Arrangement	N.O.
Mounting Type	Threaded front panel mount
Torque for Threaded Body	11.5 kgf/cm

### Mechanical Characteristics

Mechanical Life	1,000,000 cycles
Total Travel	1.8 ± 0.2 mm
Operating Force	4.5 ± 1.5N

### Electrical Characteristics

Contact Rating	2A / 36 VDC
Operating Life	Make-and-break cycles at full load 200,000
Dielectric Strength	2,000 V RMS @ sea level
Insulation Resistance	1,000 MΩ min. @ 500 VDC
Initial Contact Resistance	50 mΩ max @ 1A 12 VDC
Operating Temperature	-20°C to 70°C
Sealing / Protection	IP67

### Description

The ATPS22 series anti-vandal short body sealed pushbutton switch is designed to withstand deliberate damage and vandalism, which in turn can reduce the need for costly in-field repairs and product recalls. Besides being vandal proof, the new pushbutton switches share many characteristics of other ATP pushbuttons in the range, including being lightweight, IP67-rated and corrosion resistant. As the devices integrating this switch are often outdoors, the ATPS22 pushbutton has been designed to withstand extreme environmental conditions and water exposure.

### Features & Benefits

- Momentary
- IP67 sealed & IK10 (Stainless steel bushing)
- Rated at 2A / 36 Vdc
- 1,000,000 mechanical lifecycles
- Various colors of LED illuminate indicator
- Choices of actuator with ring or power logo
- RoHS compliant

### Applications

- Alarm, safety & security systems
- Intercom "push-to-talk" devices
- Automatic food & drink vending machines
- Parking lot ticket machines & ticket paying stations
- Industrial instruments

### Materials

Bushing	Stainless steel
Base	PA66, white (UL 94 V-0)
Actuator	PC, translucent (UL 94 V-2), std steel
Internal Assembly	PC, transparent (UL 94 V-2)
Spring	Steel
Sealing / O-ring	Silicone (Translucent) / Silicone
Terminals	Brass, gold flash plated
Contact	Brass, coin sliver, gold flash plated

#### Notes:

Specifications and materials listed above are for switches with standard options. For information on specific and custom switches, please contact Customer Service.

# ATPS22 Series

## Anti-Vandal Short-Body Sealed Pushbutton Switch



### Ordering Number

To order, simply select desired option from each category and place in the appropriate box.

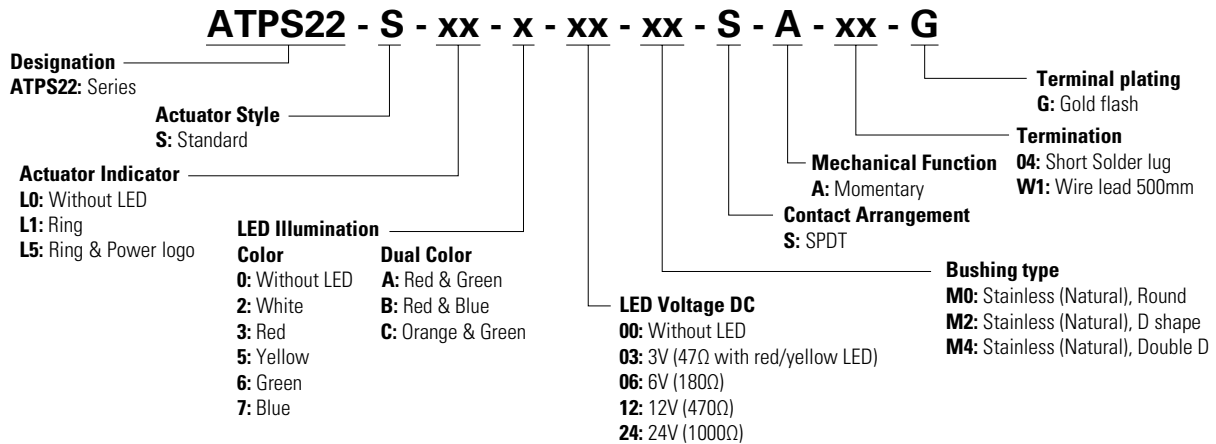

### Standard View inches (mm)

#### Standard

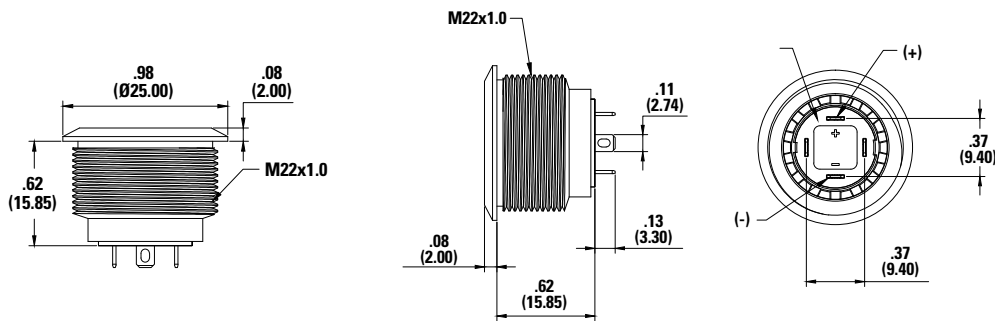

### Actuator Indicator inches (mm)

#### L0 Without LED

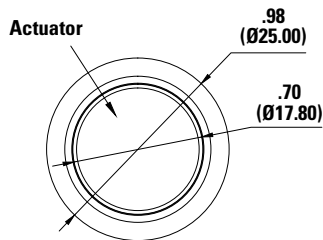

#### L1 Ring

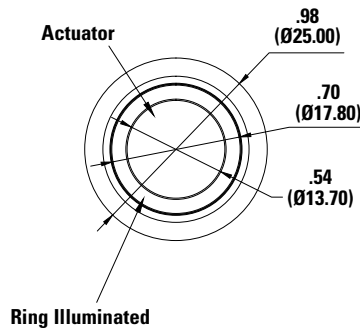

#### L5 Ring & Power

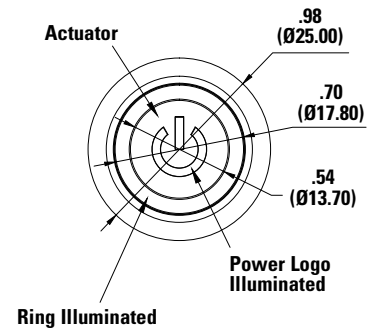

# ATPS22 Series

## Anti-Vandal Short-Body Sealed Pushbutton Switch



### Without LED

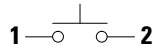

### Single Color LED

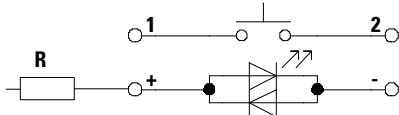

### Dual Color LED

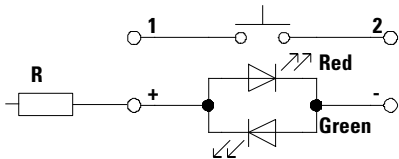

**Notes:**

**R:** Resistor value is according to the LED voltage applied.

### Circuit

### Resistor Value

Resistor value (Apply LED voltage)
LED input 3 VDC, 47 ohms (Red/Yellow/Orange LED type only)
LED input 6 VDC, 180 ohms
LED input 12 VDC, 470 ohms
LED input 24 VDC, 1000 ohms

**Notes:**

Ohms value of resistance tolerance: ±5%

### Termination inches (mm)

#### W1 Wire Lead 500mm<sup>1</sup>

Multi-wire lead AWG20, Section 0.6 mm<sup>2</sup>, UL approved

#### 04 Solder Lug

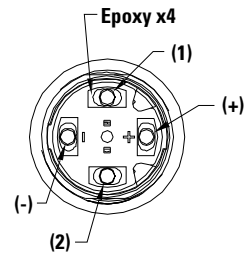
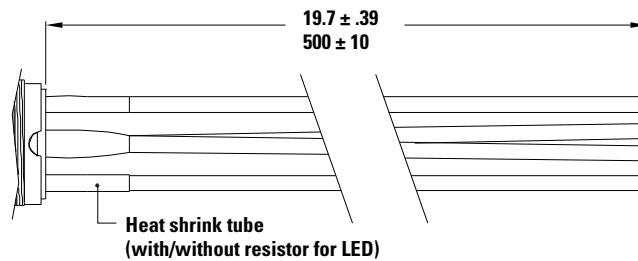
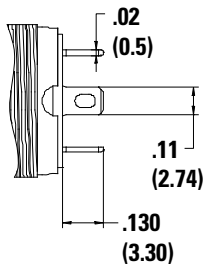

### Non-LED

Description	Wire color
Terminal 1	Black
Terminal 2	

### With LED

Description	Wire color
Terminal 1	Black
Terminal 2	
LED+	Red
LED-	Green

**Note:**

Special length, please consult your sales representative for details.

### Resistor Combination

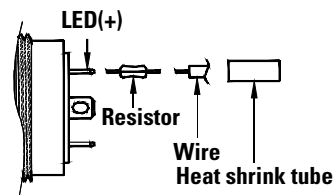

# ATPS22 Series

## Anti-Vandal Short-Body Sealed Pushbutton Switch



### Panel Cutout inches (mm)

M0 Round

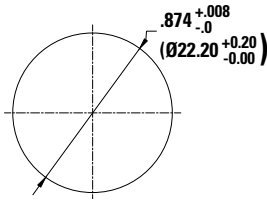

M2 D Shape

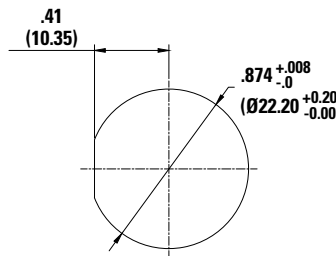

M4 Double D

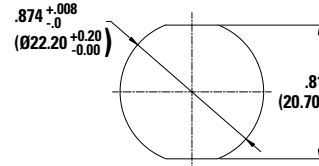

### Hardware inches (mm)

Hex Nut  
Order PN: ATP22-HN

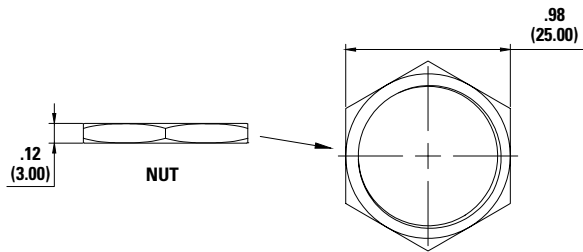

O Ring  
Order PN: ATP22-OR

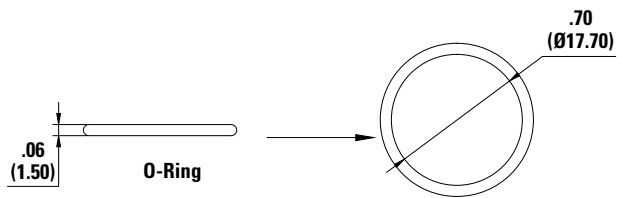

**Disclaimer Notice** - Information furnished is believed to be accurate and reliable. However, users should independently evaluate the suitability of and test each product selected for their own applications. Littelfuse products are not designed for, and may not be used in, all applications. Read complete Disclaimer Notice at <http://www.littelfuse.com/disclaimer-electronics>.